

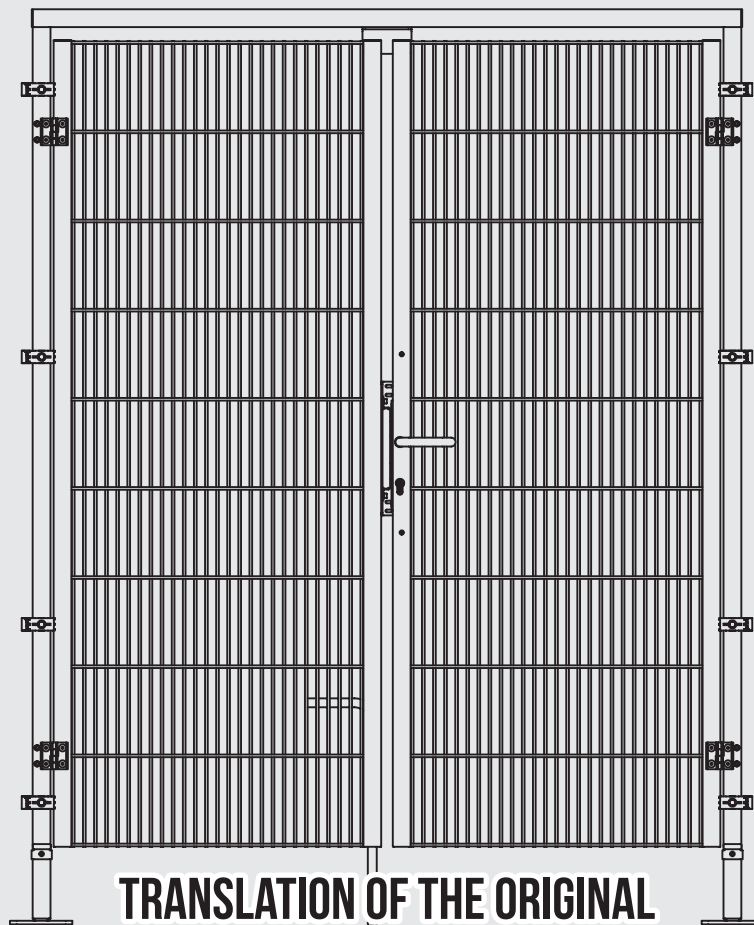

These operating instructions contain important product information and safety instructions. This information must be taken into consideration prior to carrying out any activities relating to the product and observed throughout. These operating instructions must be made available to all parties and stored in a safe place.



...we protect people!



**TRANSLATION OF THE ORIGINAL  
OPERATING INSTRUCTIONS**

**ECONFENCE®**  
protection · german made

**MEDIUM LINE**

**2-LEAF SWING DOOR**

**VARIANT BT01**

**System heights 2000 | 2400 mm**

**Version: 01/2018**



## NOTES

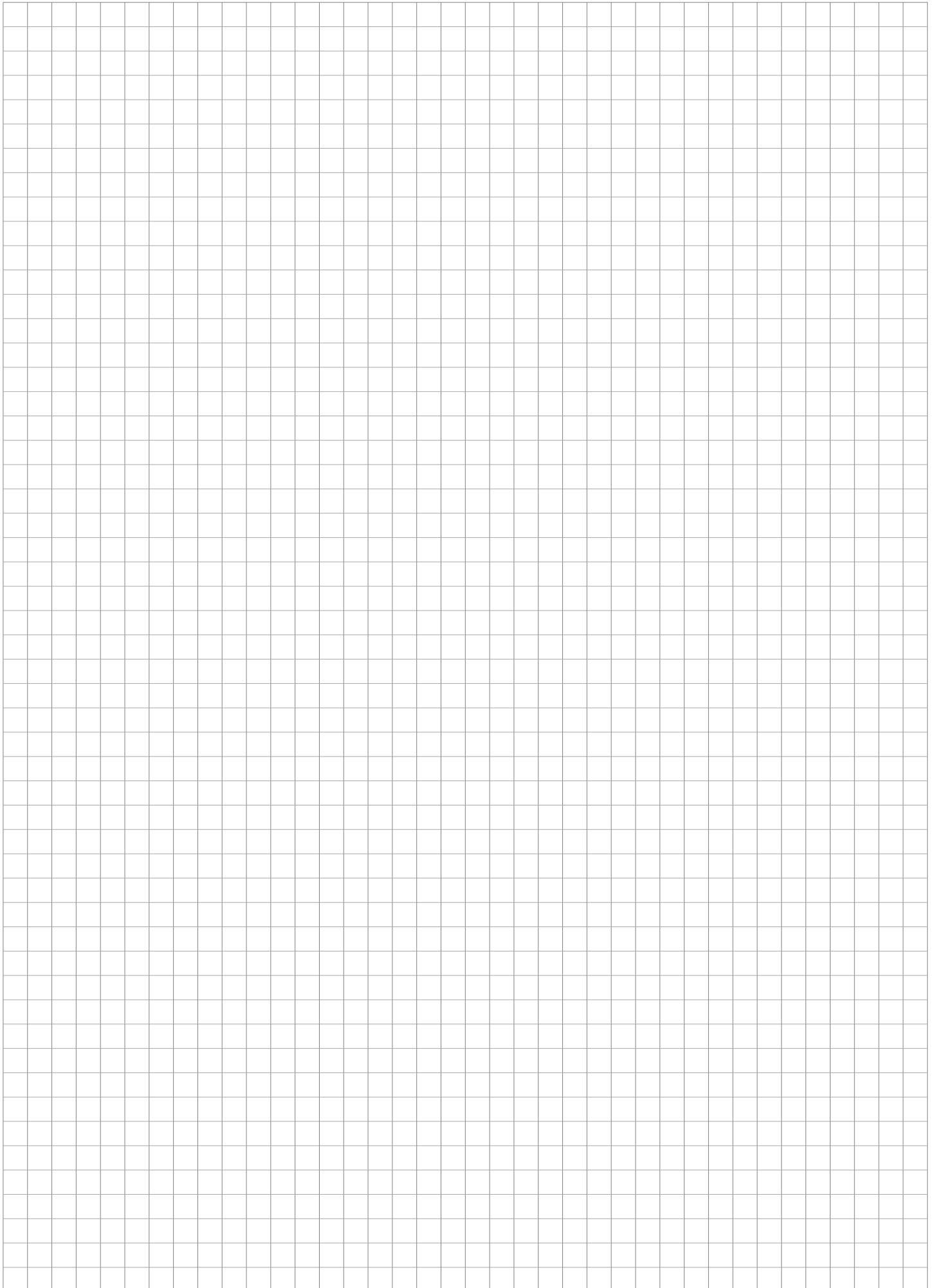

## Table of contents

<b>1.</b>	<b>Product description and technical data</b>	<b>Page 4</b>
<b>2.</b>	<b>Intended use and limitations</b>	<b>Page 5</b>
<b>3.</b>	<b>EC Declaration of Conformity</b>	<b>Page 6</b>
<b>4.</b>	<b>Safety instructions and explanation of symbols</b>	<b>Page 7</b>
<b>5.</b>	<b>Assembly and installation</b>	<b>Page 8 - 14</b>
	<b>5.1. Essential tools</b>	<b>Page 9</b>
	<b>5.2. Fastening to the substrate</b>	<b>Page 10</b>
	<b>5.3. Interface for fixing locking devices</b>	<b>Page 11</b>
	<b>5.4. Installation on the protective mesh</b>	<b>Page 12</b>
<b>6.</b>	<b>Maintenance</b>	<b>Page 14</b>
<b>7.</b>	<b>Disassembly and disposal</b>	<b>Page 14</b>
<b>8.</b>	<b>Accessories</b>	<b>Page 15</b>

# 1. Product description and technical data

The 2-leaf swing doors of the variant BT01 are available in the following designs as standard:

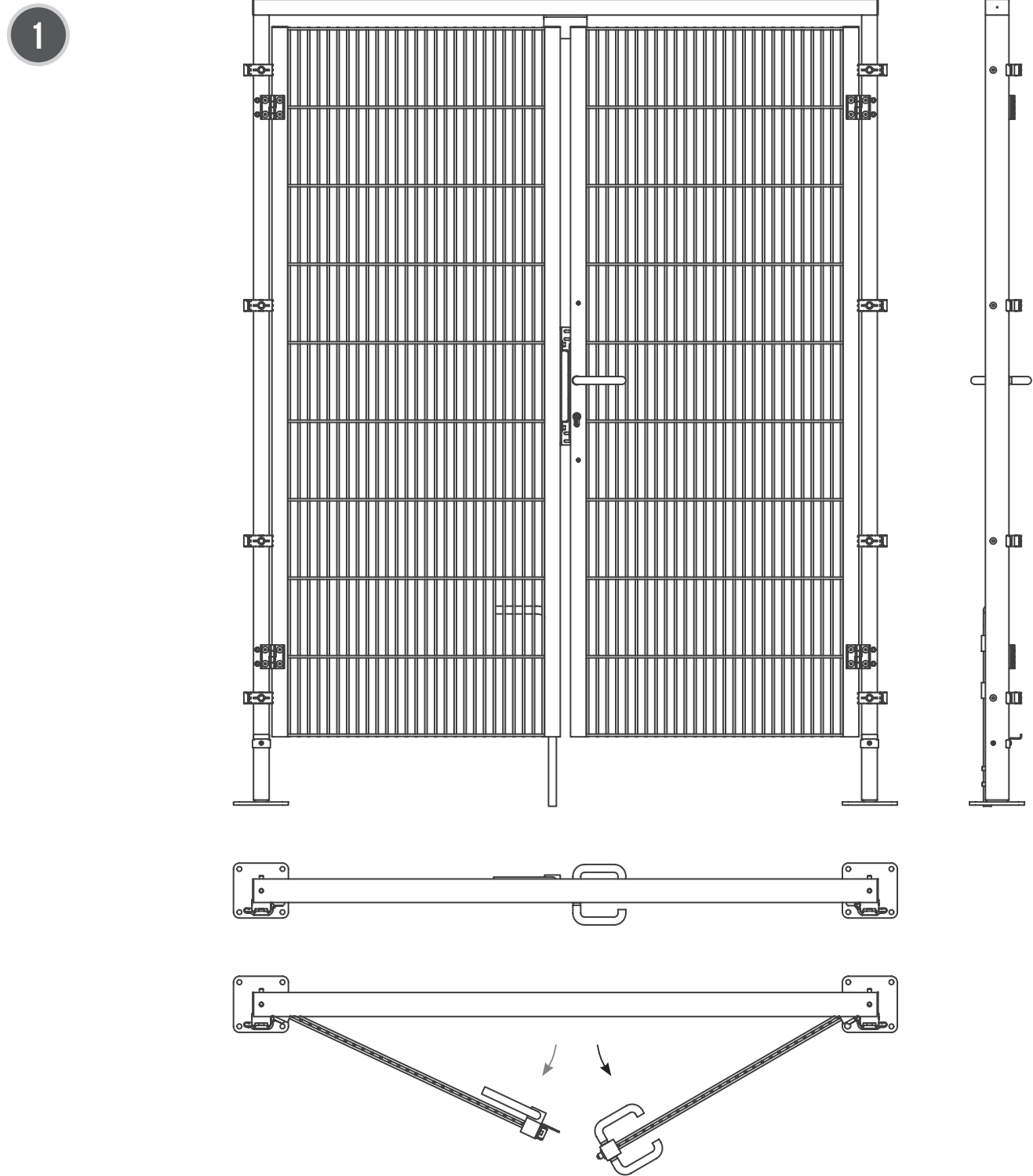

MEDIUM LINE	Widths (mm)	Opening width (mm)	Heights: (mm)	Base plate (mm)	Weights (kg)
1 2-leaf swing door Variant BT01	1690	1390	2053	140x140	69.26
	1690	1390	2453	140x140	81.40
	2090	1790	2053	140x140	78.65
	2090	1790	2453	140x140	92.57
	2895	2595	2053	140x140	97.42
	2895	2595	2453	140x140	114.89

## 2. Intended use and limitations

The ECONFENCE® MEDIUM LINE protective fencing system is designed to establish a fixed, safe distance to protect people from coming into contact with hazardous machinery and facilities in automation and production.

The fencing elements are suitable for use as fixed guards and the 2-leaf swing doors of the variant BT01 are designed – in combination with locking devices with door handles (in the sense of DIN EN ISO 14119) – for use as movable guards

(in the sense of DIN EN ISO 14120).

The locking devices themselves and their fastening accessories are not part of the scope of delivery. The system manufacturer is responsible for the expert layout and installation of suitable locking devices. This expertise also includes an understanding and observance of the relevant legislation governing safety technology, including e.g. DIN EN ISO 13849. Application of the CE mark provided (type plate) is prohibited until the doors have been completed by the necessary locking devices.

Only operate the guard when it is in perfect technical condition! Taking health and safety at work into account, eliminate any problems which can impair the safety of employees and operational safety without delay!

Any other use shall require the written approval of the manufacturer. If machines or systems are not surrounded entirely by the protective fencing system, the open areas (such as material transfer points and personnel access points) must be secured by the plant engineer in accordance with the risk assessment and the relevant legislation.

Intended use also includes taking the operating instructions into consideration and observing the cleaning, maintenance and inspection conditions. The guard has been designed for industrial machine and system construction and may only be mounted, operated, maintained and repaired by trained, instructed specialists.

The owner / operator must check whether the currently valid standards and regulations require the protective fencing to have a protective earth connection.

The protective earth connection may only be carried out by a qualified electrician.

When incorporating the protective fencing system into the overall security concept of the machine or system, the following standards must be taken into consideration:

DIN EN ISO 12100	Safety of machinery – General principles for design – Risk assessment and risk reduction
DIN EN ISO 11161	Safety of machinery – Integrated manufacturing systems – Basic requirements
DIN EN ISO 13857	Safety of machinery – Safety distances to prevent hazard zones being reached by upper and lower limbs
DIN EN 349	Safety of machinery – Minimum gaps to avoid crushing parts of the human body
DIN EN ISO 14120	Safety of machinery – Guards – General requirements for the design and construction of fixed and movable guards
DIN EN ISO 14119	Safety of machinery – Interlocking devices associated with guards – Principles for design and selection
DIN EN ISO 13849-1	Safety of machinery – Safety-related parts of control systems – Part 1: General principles for design

Depending on the machine / system constellation, other standards which are not listed here must also be taken into consideration.

The system is not intended for outdoor use. Any kind of manipulation is prohibited.

The protective fencing may only be set up in an environment with temperatures from 10°C to max. 50°C (not corrosive environment).

The machine / system must be switched off before anyone enters the hazardous area (electrical, pneumatic) and secured against unauthorised restarting by means of a lockout/tagout lock. The key must always be carried on your person.







...we protect people!

TIEMANN  
Schutz-Systeme GmbH  
Lübbecker Straße 16  
32257 Bünde | Germany

Phone +49 (0)5223 791995-0 info@econference.com  
Fax +49 (0)5223 791995-90 www.econference.com

**EG-KONFORMITÄTSERKLÄRUNG**  
im Sinne der EG Maschinenrichtlinie 2006/42/EG, Anhang II A  
**EC DECLARATION OF CONFORMITY**  
according to EC Machinery Directive 2006/42/EC, Annex II A

**Hersteller | Manufacturer**  
**Tiemann Schutz-Systeme GmbH**  
 Lübbecker Straße 16  
 32257 Bünde / Germany

**Hiermit erklären wir, dass das Produkt:**  
**Produktbezeichnung:** Bewegliche Trennende Schutzeinrichtung  
**Typ:** ECONFENCE® MEDIUM LINE BT01  
**Baujahr bzw. Seriennummer:** ab 05/2016  
 den einschlägigen Bestimmungen der Richtlinie 2006/42/EG entspricht.  
**Es wurden folgende harmonisierte Normen angewandt:**

- DIN EN ISO 14120:2016-05

**We hereby declare that the product:**  
**Product designation:** Movable separating guard  
**Type:** ECONFENCE® MEDIUM LINE BT01  
**Year of build or serial number:** as of 05/2016  
 meets the relevant provisions of Directive 2006/42/EC.  
**The following harmonised standards have been applied:**









- DIN EN ISO 14120:2016-05

Ort City	Datum Date	Unterschrift* Signature*	Axel W. Tiemann Geschäftsführer Managing Director
-------------	---------------	-----------------------------	---

Der Hersteller ist verantwortlich für die Zusammenstellung der technischen Unterlagen und gleichzeitig der verantwortliche Herausgeber der technischen Dokumentation.  
 The manufacturer is responsible for not only compiling the technical documents, but also issuing the technical documentation.

#### 4. Safety instructions and explanation of symbols

The safety symbols are to be noted and observed in each of the relevant sections of these operating instructions.

Symbol	Explanation
	<b>Safety instruction</b> (Failure to observe will result in injury or death)
	<b>Functional instruction</b> (Failure to observe will result in malfunctions or material damage)
	Hazardous area
	Non-hazardous area
	Magnified/detailed view
	Installation height
	Essential tools (reference to page 9)
	Use ear protectors
	Use protective eyewear

## 5. Assembly and installation



At least two people are required for assembly and installation. Wear personal protective equipment or fastened working clothes, wear safety footwear and head protection. In addition, goggles with side protectors must be worn during drilling in concrete. If dusts occur, filter mask of at least FFP 1 must be worn. Only specialist personnel are authorised to carry out assembly and installation. Prior to commencing the installation work, the machine or system being enclosed must be switched off or else made safe. The machine / system must be switched off before installation and secured against unauthorised restarting by means of a lock-out/tagout lock. The key must always be carried on your person. Establish / check the required safety distances from the hazardous areas of the machine/system in accordance with DIN EN ISO 13857:

**Safety distances according to DIN EN ISO 13857**

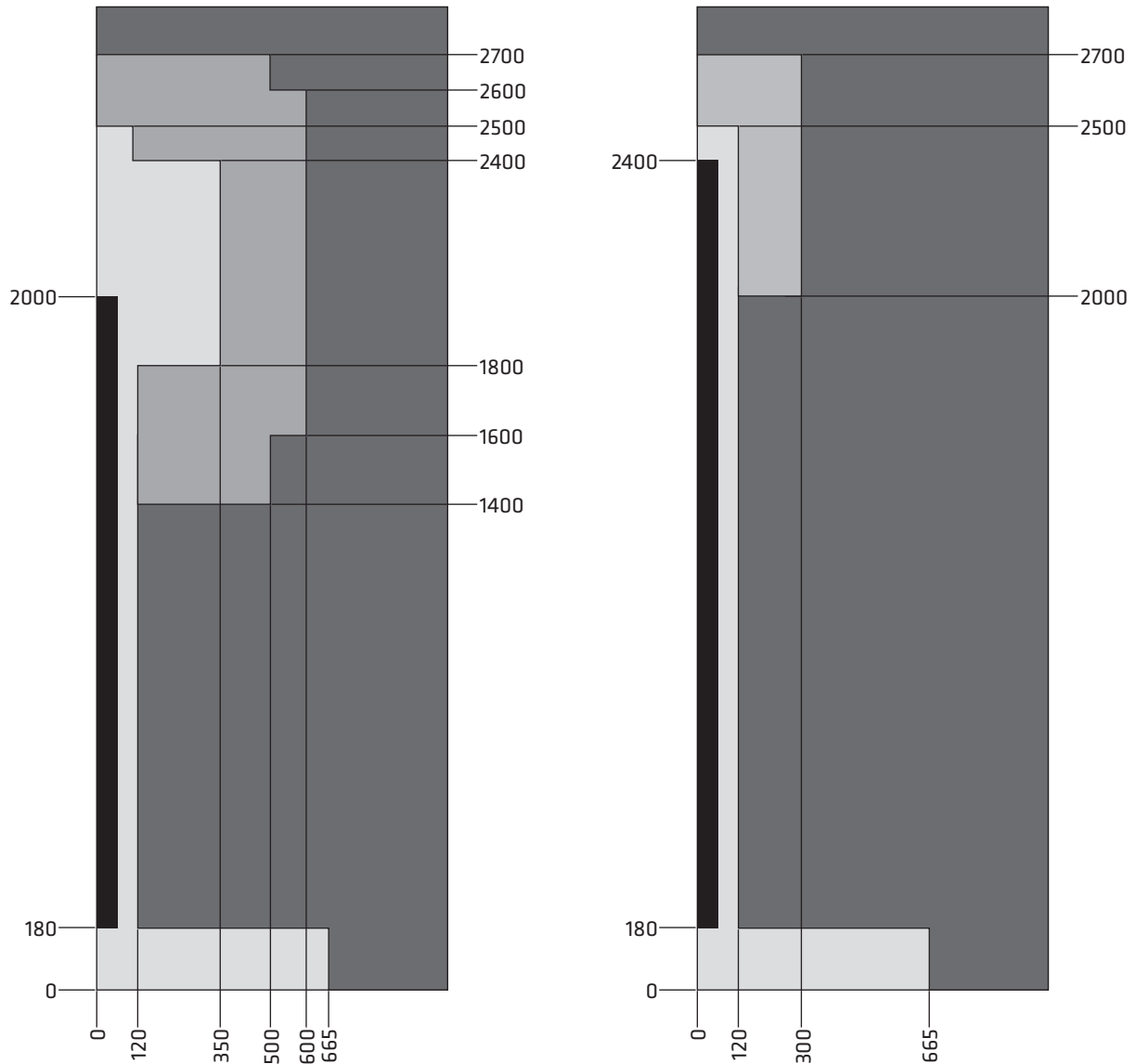

Low risk

High risk

Please note: In the event of a risk posed by slips or misuse, the use of safety distances to prevent hazardous zones being reached by lower limbs in accordance with DIN EN ISO 13857, Annex B may not be suitable. If this is the case, then the safety distances must be defined by the plant manufacturer in accordance with the risk assessment.



Safety distances only apply with the use of ECONFENCE® mesh elements with a mesh size of 19|190 mm. Information on dimensions and weight specifications of the system components can be found in Section 1. Technical data, page 4. The system is only intended to be used on the following surface (see page 10). Only the fastening elements provided are to be used. When installing the electrical equipment (such as cables, switches, control cabinet etc.) for the protective fencing system, the requirements of DIN EN 60204-1 must be observed.

Should you have any further questions, please contact our Customer Service team on +49 (0) 5223 791995-0



## 5.1. Essential tools

Product



Tools

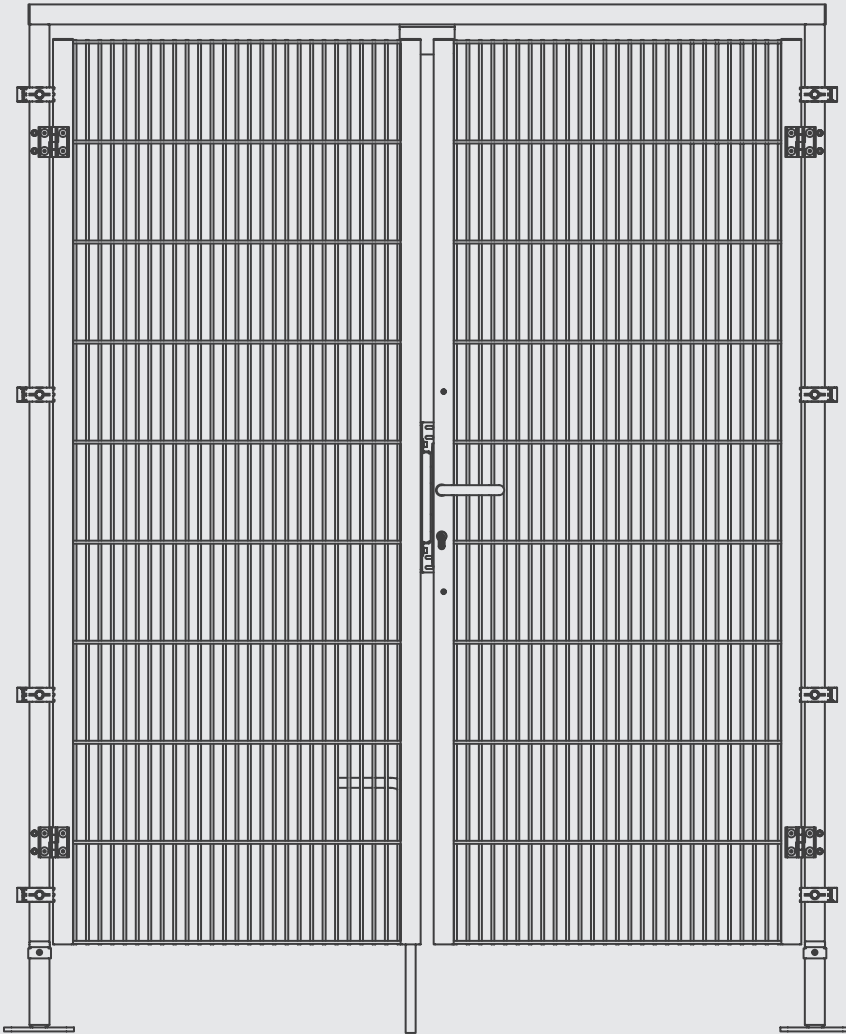

**Drill with 10 mm concrete drill bit**  
**Hammer**  
**13 mm and 17 mm socket wrenches**  
**6 mm Allen key**

**2-leaf swing door, variant BT01, installation (page 10-13)**

## 5.2. Fastening to the substrate

Substrate material: Concrete (uncracked) C20/25 to C50/60



See page 9

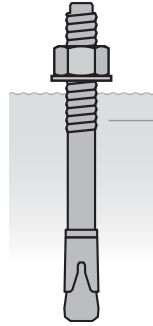
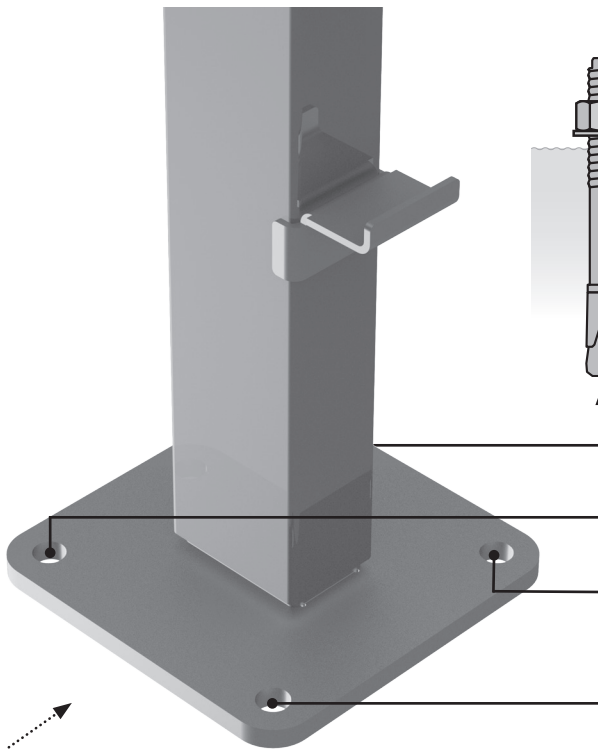
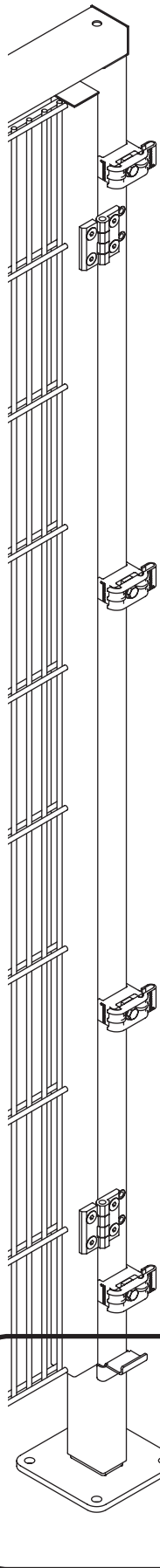

4 x  HSA M10x113 50/40/10

Top view

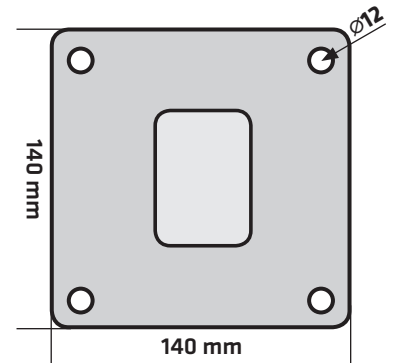

### Technical data:

Dowel size	M10
Dowel length	113 mm
Approvals	ETA-11/0374
Substrate material	Concrete (uncracked) C20/25 - C50/60
Environmental factors	Indoors, dry
Edge clearance	50 mm
Operating principle	Torque-controlled expansion anchor
Standard embedment depth	50 mm
Nominal drill diameter	10 mm
Drill hole depth	80 mm
Required tightening torque	25 Nm

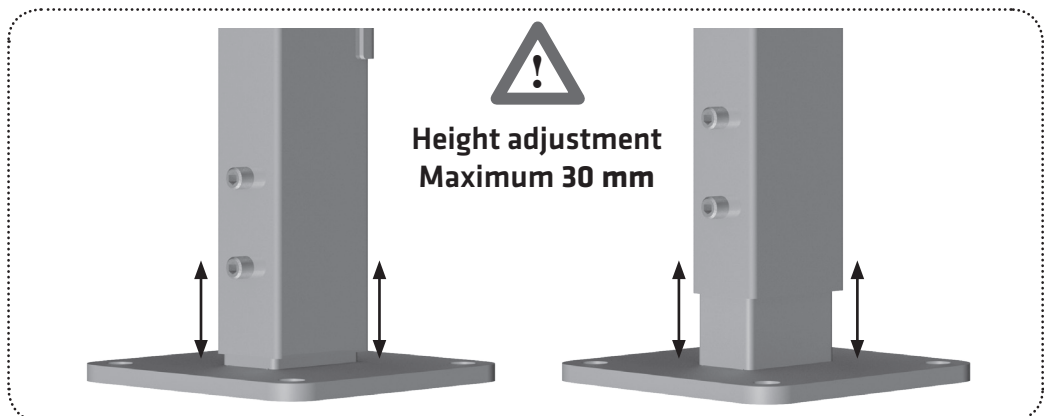

### 5.3. Interface for fixing locking devices 2-leaf swing door, variant BT01, as a movable guard in connection with an on-site locking device



*For the locking device (safety switch) to be fixed in place, threaded rivets can be set on the door leaf and post in the upper area of the inner side of the door (see illustration below, area marked grey).*

**i** Should you have any further questions, please contact us on +49 (0) 5223 791995-0.

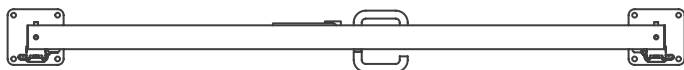
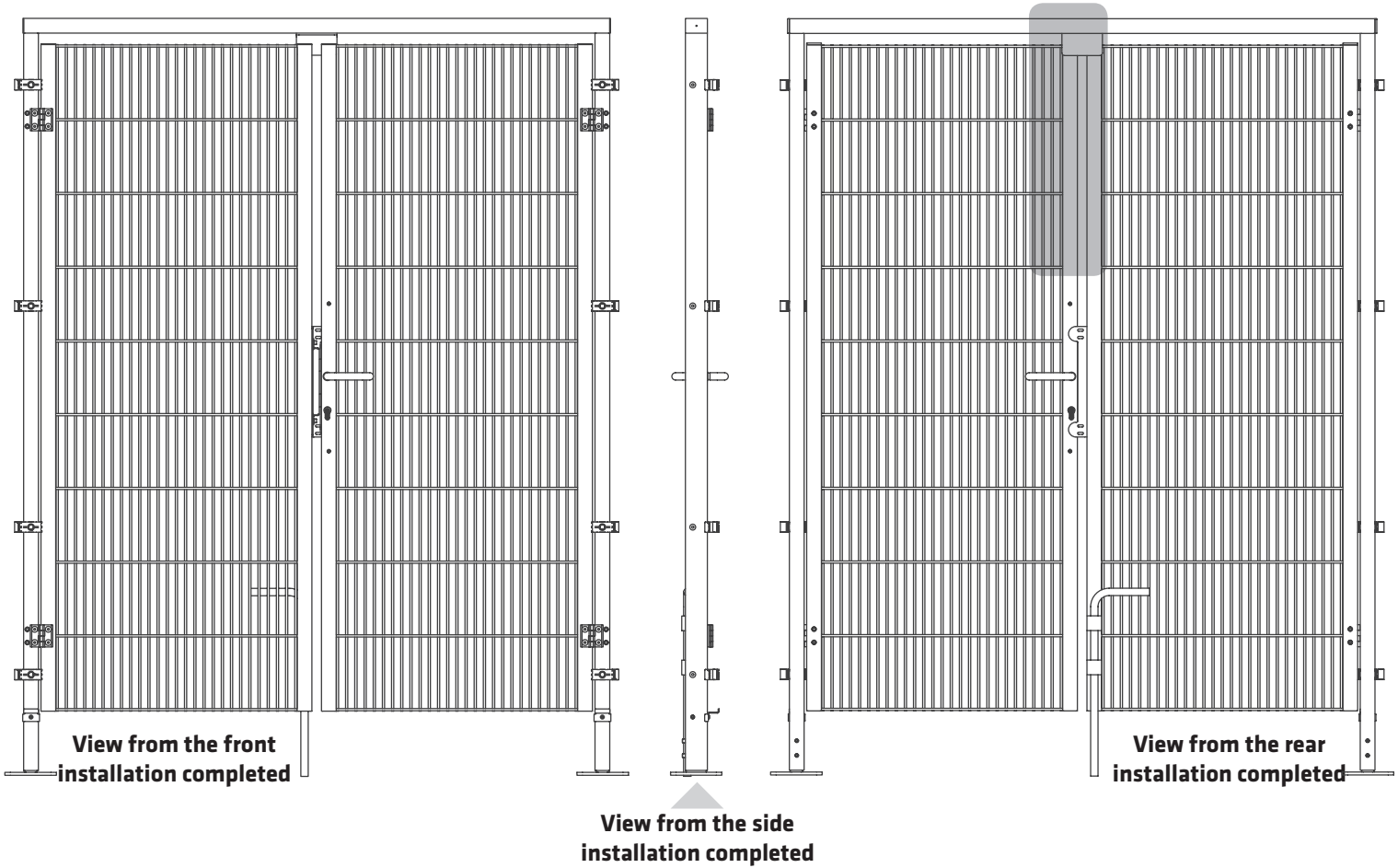

**View from above  
installation completed**

## 5.4. Installation on the protective mesh

 2053 / 2453 mm

 See page 10

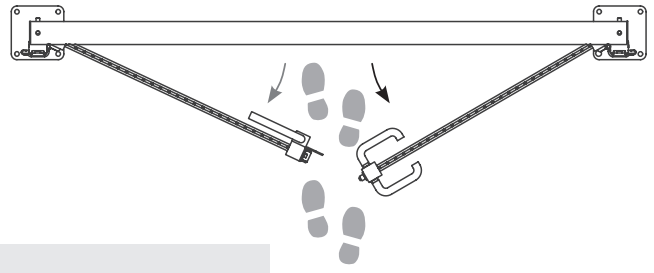

**With mesh assembly  
always make sure that the correct number of vertical mesh  
rods are in the clamping element**  
(see Fig. 1 und 2)

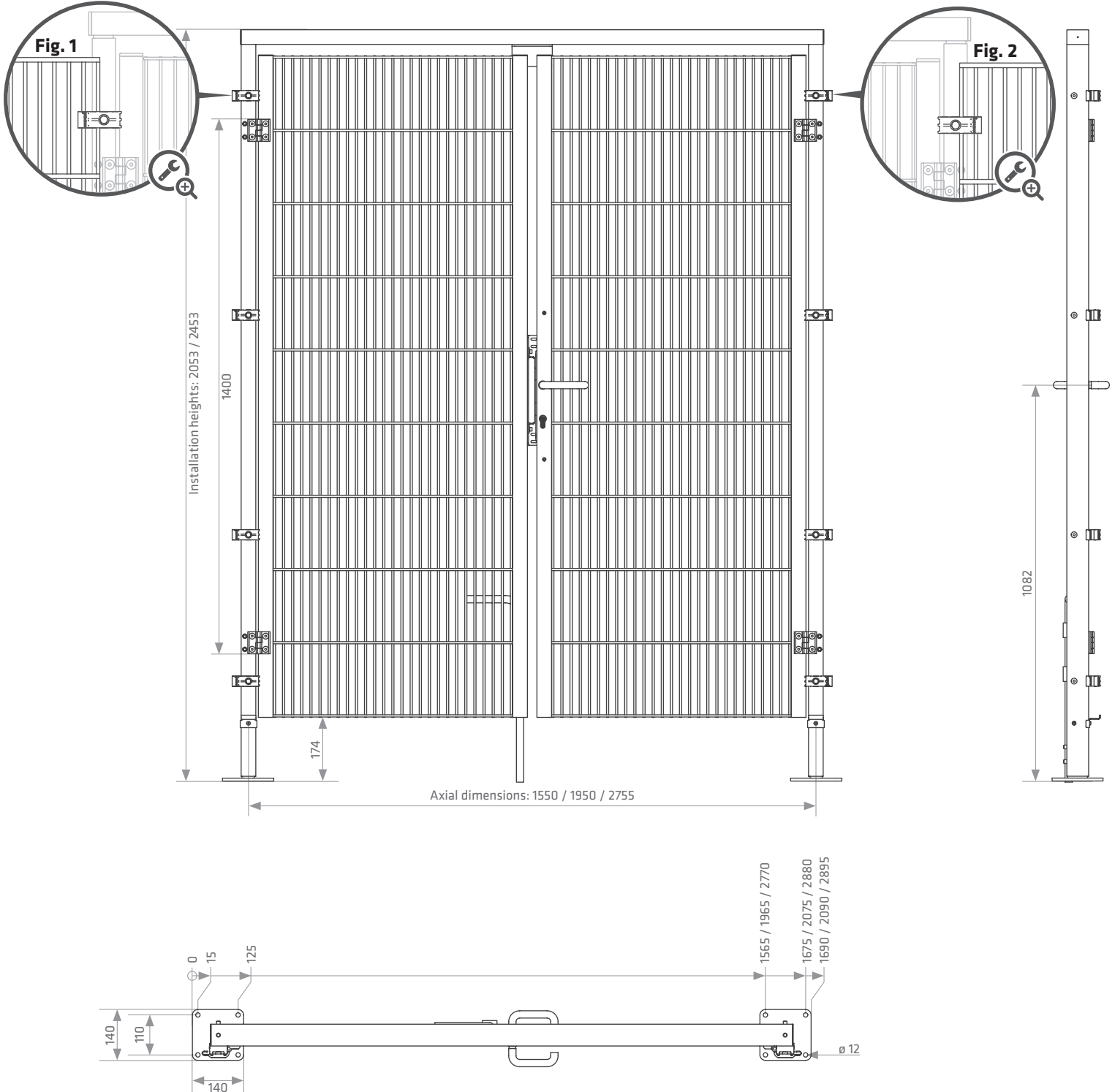

# NOTES

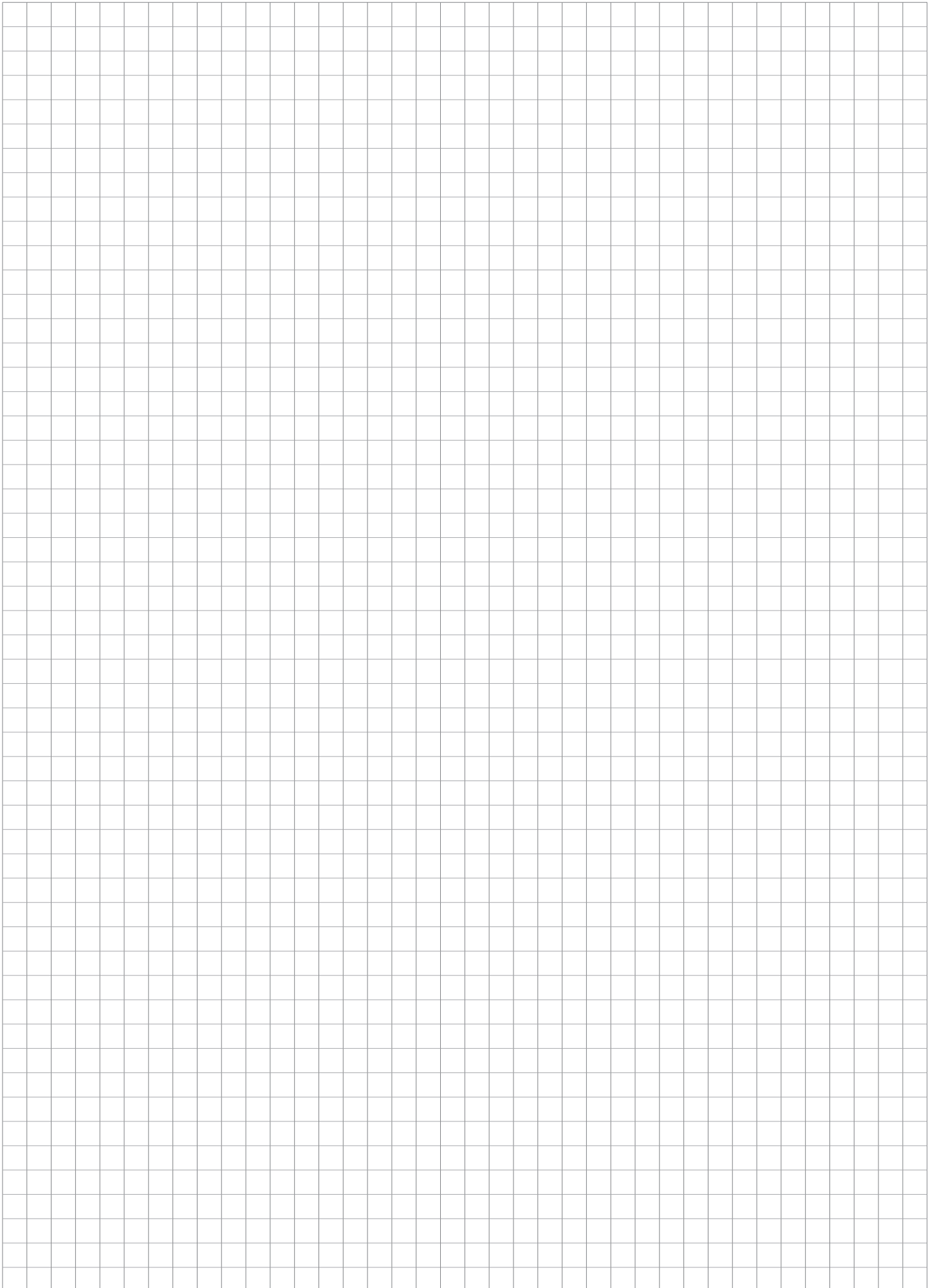

## 6. Maintenance

The ECONFENCE® protective fencing system is essentially maintenance-free.



Annual checks are to be carried out by specialist personnel to ensure its protective function remains intact. Missing and/or damaged parts must be completed or replaced immediately, taking health and safety at work into account. Only original spare parts may be used.

## 7. Disassembly and disposal

At least two people are required for disassembly work and these must be specialist personnel.



The machine / system must be switched off before disassembly and secured against unauthorised restarting by means of a lockout/tagout lock. The key must always be carried on your person.

Any electrical equipment attached to the protective fencing system must be disconnected or else made safe.

The system must be disposed of in line with local regulations.

## 8. Spare parts and accessories

Order no.	Designation	Fig.
ZB20097	Post cap with collar, black plastic, for a post profile measuring 60x40mm	1
ZB31001	Clamping element, black plastic, clamping range 6 mm, with pre-assembled steel screw M8x40 mm	2
ZB21014	Mesh support, row post (rivet version), black plastic, for a post profile measuring 60x40 mm	3
ZB21010	Mesh support, corner post (rivet version), black plastic, for a post profile measuring 60x40mm	4
ZB20024	Aluminium threaded rivet sleeve M8, for drill hole $\varnothing$ 11.1 mm	5
ZB31055	Lower mesh connector for HL/ML row post for post profile 60x40mm, with screw	6
ZB31056	Lower mesh connector for HL/ML corner post, left, for post profile 60x40mm, with screw	7
ZB31057	Lower mesh connector for HL/ML corner post, right, for post profile 60x40mm, with screw	8
ZB31058	Assembly kit mesh fixing (rivet version) for HL/ML row post: 5 x ZB31001, clamping element, black plastic 6 mm, with pre-assembled steel screw 5 x ZB21014, mesh support row post (rivet version), black plastic 5 x ZB20024, aluminium threaded rivet sleeve M8, for drill hole $\varnothing$ 11.1 mm 1 x ZB31055, lower mesh connector for HL/ML row post, with screw	
ZB31059	Assembly kit mesh fixing (rivet version) for HL/M corner or door corner post, left: 5 x ZB31001, clamping element, black plastic 6 mm, with pre-assembled steel screw 5 x ZB21010, mesh support corner post (rivet version), black plastic 5 x ZB20024, aluminium threaded rivet sleeve M8, for drill hole $\varnothing$ 11.1 mm 1 x ZB31056, lower mesh connector for corner post, left, with screw	
ZB31060	Assembly kit mesh fixing (rivet version) for HL/M corner or door corner post, right: 5 x ZB31001, clamping element, black plastic 6 mm, with pre-assembled steel screw 5 x ZB21010, mesh support corner post (rivet version), black plastic 5 x ZB20024, aluminium threaded rivet sleeve M8, for drill hole $\varnothing$ 11.1 mm 1 x ZB31057, lower mesh connector for corner post, right, with screw	
S00001	Post insert base for profiles measuring 60x40 mm, 140x140 mm plate, galvanised	9
TSM-10221	Bottom arresting device	10
ZB20025	Hilti stud anchor, galvanised steel, HSA M10x113 50/40/10 for non-cracked concrete	
ZB20027	Hilti capsule adhesive anchor HVU M10x90 with anchor rod HAS M10x90/21 for non-cracked concrete	
ZB20054	Paint spray, RAL 7035 - light grey, 400 ml, gloss	
ZB20055	Paint spray, RAL 1021 - colza yellow, 400 ml, gloss	
ZB20056	Paint spray, RAL 9005 - jet black, 400 ml, gloss	
ZB20057	Paint spray, RAL 9005 - jet black, 400 ml, matt	
ZB40005	Mesh customisations and recesses according to customer layout	

Technical specifications subject to change.



Should you have any further questions, please contact us on +49 (0) 5223 791995-0.

Fig. 1



Fig. 2



Fig. 3

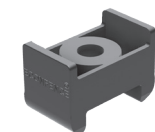

Fig. 4

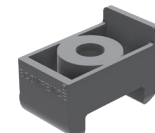

Fig. 5



Fig. 6

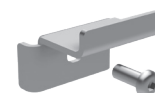

Fig. 7

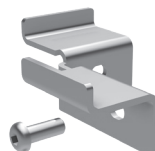

Fig. 8

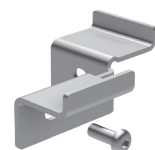

Fig. 9

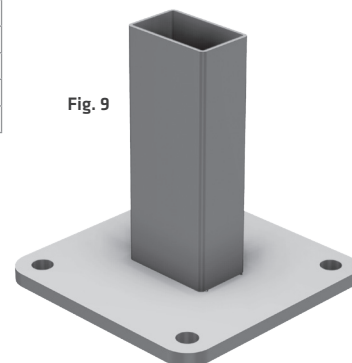

Fig. 10





...we protect people!

**TIEMANN**  
**Schutz-Systeme GmbH**  
**Lübbecker Straße 16**  
**32257 Bünde**  
**Germany**  
**Fon +49 (0)5223 791995-0**  
**Fax +49 (0)5223 791995-90**  
**www.econfence.com**  
**info@econfence.com**



BA-100027-2