

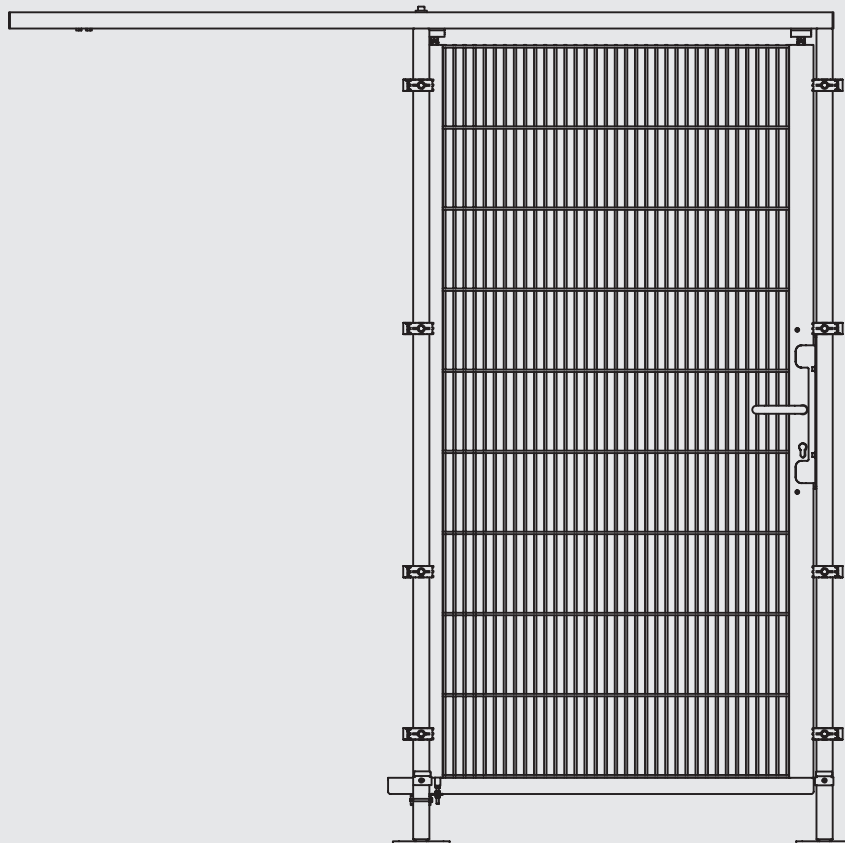

These operating instructions contain important product information and safety instructions. This information must be taken into consideration prior to carrying out any activities relating to the product and observed throughout. These operating instructions must be made available to all parties and stored in a safe place.



...we protect people!



TRANSLATION OF THE ORIGINAL OPERATING INSTRUCTIONS

ECONFENCE®
protection · german made

MEDIUM LINE

1-LEAF SLIDING DOOR

VARIANT BT01

System heights 2000 | 2400 mm

Version: 01/2018



NOTES

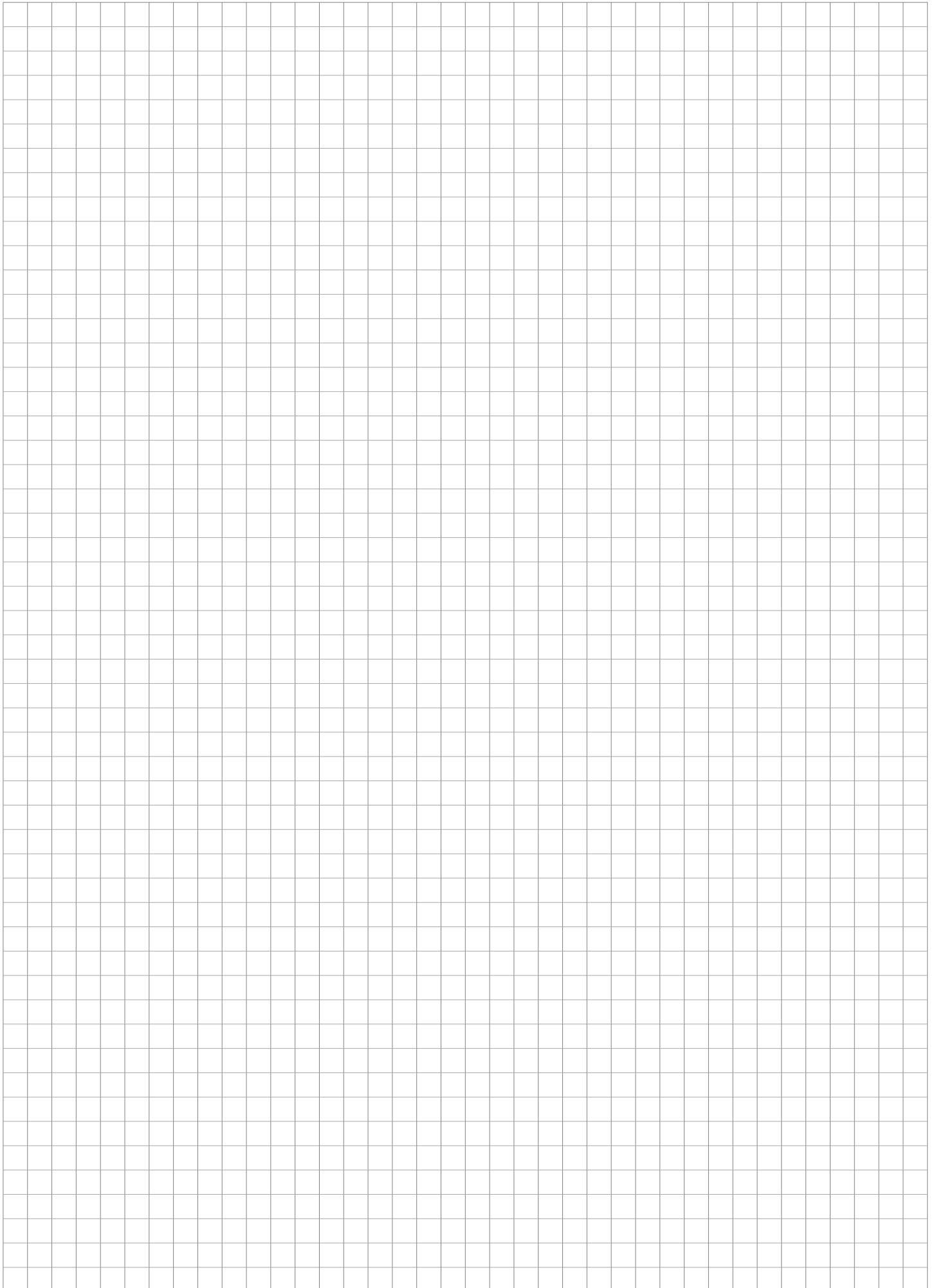

Table of contents

1.	Product description and technical data	Page 4
2.	Intended use and limitations	Page 5
3.	EC Declaration of Conformity	Page 6
4.	Safety instructions and explanation of symbols	Page 7
5.	Assembly and installation	Page 8 - 14
	5.1. Essential tools	Page 9
	5.2. Fastening to the substrate	Page 10
	5.3. Interface for fixing locking devices	Page 11
	5.4. Installation on the protective mesh	Page 12 - 13
6.	Maintenance	Page 14
7.	Disassembly and disposal	Page 14
8.	Accessories	Page 15

1. Product description and technical data

The 1-leaf sliding doors of the variant BT01 are available in the following designs as standard:

1

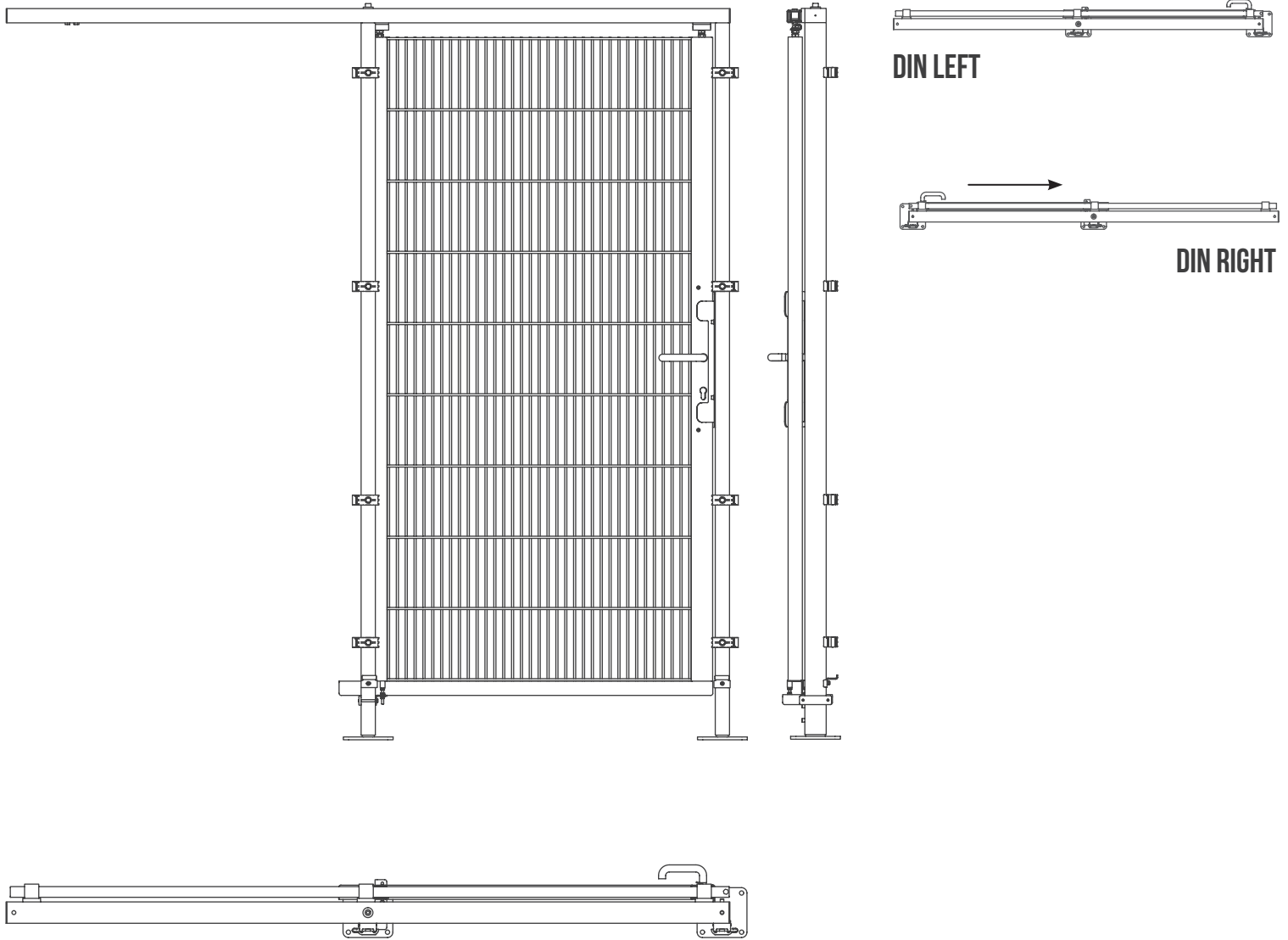

MEDIUM LINE	Widths (mm)	Opening width (mm)	Heights: (mm)	Base plate (mm)	Weights (kg)
1 1-leaf sliding door Variant BT01 DIN left / right	2085	718	2053	140x140	59.11
	2085	718	2453	140x140	66.97
	2755	1123	2053	140x140	70.11
	2755	1123	2453	140x140	80.41

2. Intended use and limitations



The ECONFENCE® MEDIUM LINE protective fencing system is designed to establish a fixed, safe distance to protect people from coming into contact with hazardous machinery and facilities in automation and production.

The fencing elements are suitable for use as fixed guards and the 1-leaf sliding doors of the variant BT01 are designed – in combination with locking devices with door handles (in the sense of DIN EN ISO 14119) – for use as movable guards

(in the sense of DIN EN ISO 14120).

The locking devices themselves and their fastening accessories are not part of the scope of delivery. The system manufacturer is responsible for the expert layout and installation of suitable locking devices. This expertise also includes an understanding and observance of the relevant legislation governing safety technology, including e.g. DIN EN ISO 13849. Application of the CE mark provided (type plate) is prohibited until the doors have been completed by the necessary locking devices.

Only operate the guard when it is in perfect technical condition! Taking health and safety at work into account, eliminate any problems which can impair the safety of employees and operational safety without delay!

Any other use shall require the written approval of the manufacturer. If machines or systems are not surrounded entirely by the protective fencing system, the open areas (such as material transfer points and personnel access points) must be secured by the plant engineer in accordance with the risk assessment and the relevant legislation.

Intended use also includes taking the operating instructions into consideration and observing the cleaning, maintenance and inspection conditions. The guard has been designed for industrial machine and system construction and may only be mounted, operated, maintained and repaired by trained, instructed specialists.

The owner / operator must check whether the currently valid standards and regulations require the protective fencing to have a protective earth connection.

The protective earth connection may only be carried out by a qualified electrician.

When incorporating the protective fencing system into the overall security concept of the machine or system, the following standards must be taken into consideration:

DIN EN ISO 12100	Safety of machinery – General principles for design – Risk assessment and risk reduction
DIN EN ISO 11161	Safety of machinery – Integrated manufacturing systems – Basic requirements
DIN EN ISO 13857	Safety of machinery – Safety distances to prevent hazard zones being reached by upper and lower limbs
DIN EN 349	Safety of machinery – Minimum gaps to avoid crushing parts of the human body
DIN EN ISO 14120	Safety of machinery – Guards – General requirements for the design and construction of fixed and movable guards
DIN EN ISO 14119	Safety of machinery – Interlocking devices associated with guards – Principles for design and selection
DIN EN ISO 13849-1	Safety of machinery – Safety-related parts of control systems – Part 1: General principles for design

Depending on the machine / system constellation, other standards which are not listed here must also be taken into consideration.

The system is not intended for outdoor use. Any kind of manipulation is prohibited.

The protective fencing may only be set up in an environment with temperatures from 10°C to max. 50°C (not corrosive environment).

The machine / system must be switched off before anyone enters the hazardous area (electrical, pneumatic) and secured against unauthorised restarting by means of a lockout/tagout lock. The key must always be carried on your person.

ZERTIFIKAT | CERTIFICATE





...we protect people!

TIEMANN
Schutz-Systeme GmbH
Lübbecker Straße 16
32257 Bünde | Germany

Phone +49 (0)5223 791995-0 info@econference.com
Fax +49 (0)5223 791995-90 www.econference.com

EG-KONFORMITÄTSERKLÄRUNG
im Sinne der EG Maschinenrichtlinie 2006/42/EG, Anhang II A
EC DECLARATION OF CONFORMITY
according to EC Machinery Directive 2006/42/EC, Annex II A

Hersteller | Manufacturer
Tiemann Schutz-Systeme GmbH
 Lübbecker Straße 16
 32257 Bünde / Germany

Hiermit erklären wir, dass das Produkt:
Produktbezeichnung: Bewegliche Trennende Schutzeinrichtung
Typ: ECONFENCE® MEDIUM LINE BT01
Baujahr bzw. Seriennummer: ab 05/2016
 den einschlägigen Bestimmungen der Richtlinie 2006/42/EG entspricht.
Es wurden folgende harmonisierte Normen angewandt:

- DIN EN ISO 14120:2016-05

We hereby declare that the product:
Product designation: Movable separating guard
Type: ECONFENCE® MEDIUM LINE BT01
Year of build or serial number: as of 05/2016
 meets the relevant provisions of Directive 2006/42/EC.
The following harmonised standards have been applied:









- DIN EN ISO 14120:2016-05

Ort City	Datum Date	Unterschrift* Signature*	Axel W. Tiemann Geschäftsführer Managing Director
-------------	---------------	-----------------------------	---

Der Hersteller ist verantwortlich für die Zusammenstellung der technischen Unterlagen und gleichzeitig der verantwortliche Herausgeber der technischen Dokumentation.
 The manufacturer is responsible for not only compiling the technical documents, but also issuing the technical documentation.

4. Safety instructions and explanation of symbols

The safety symbols are to be noted and observed in each of the relevant sections of these operating instructions.

Symbol	Explanation
	Safety instruction (Failure to observe will result in injury or death)
	Functional instruction (Failure to observe will result in malfunctions or material damage)
	Hazardous area
	Non-hazardous area
	Magnified/detailed view
	Installation height
	Essential tools (refer to page 9)
	Use ear protectors
	Use protective eyewear

5. Assembly and installation



At least two people are required for assembly and installation. Wear personal protective equipment or fastened working clothes, wear safety footwear and head protection. In addition, goggles with side protectors must be worn during drilling in concrete. If dusts occur, filter mask of at least FFP 1 must be worn.

Only specialist personnel are authorised to carry out assembly and installation.

Prior to commencing the installation work, the machine or system being enclosed must be switched off or else made safe. The machine / system must be switched off before installation and secured against unauthorised restarting by means of a lock-out/tagout lock. The key must always be carried on your person. Establish / check the required safety distances from the hazardous areas of the machine/system in accordance with DIN EN ISO 13857:

Safety distances according to DIN EN ISO 13857

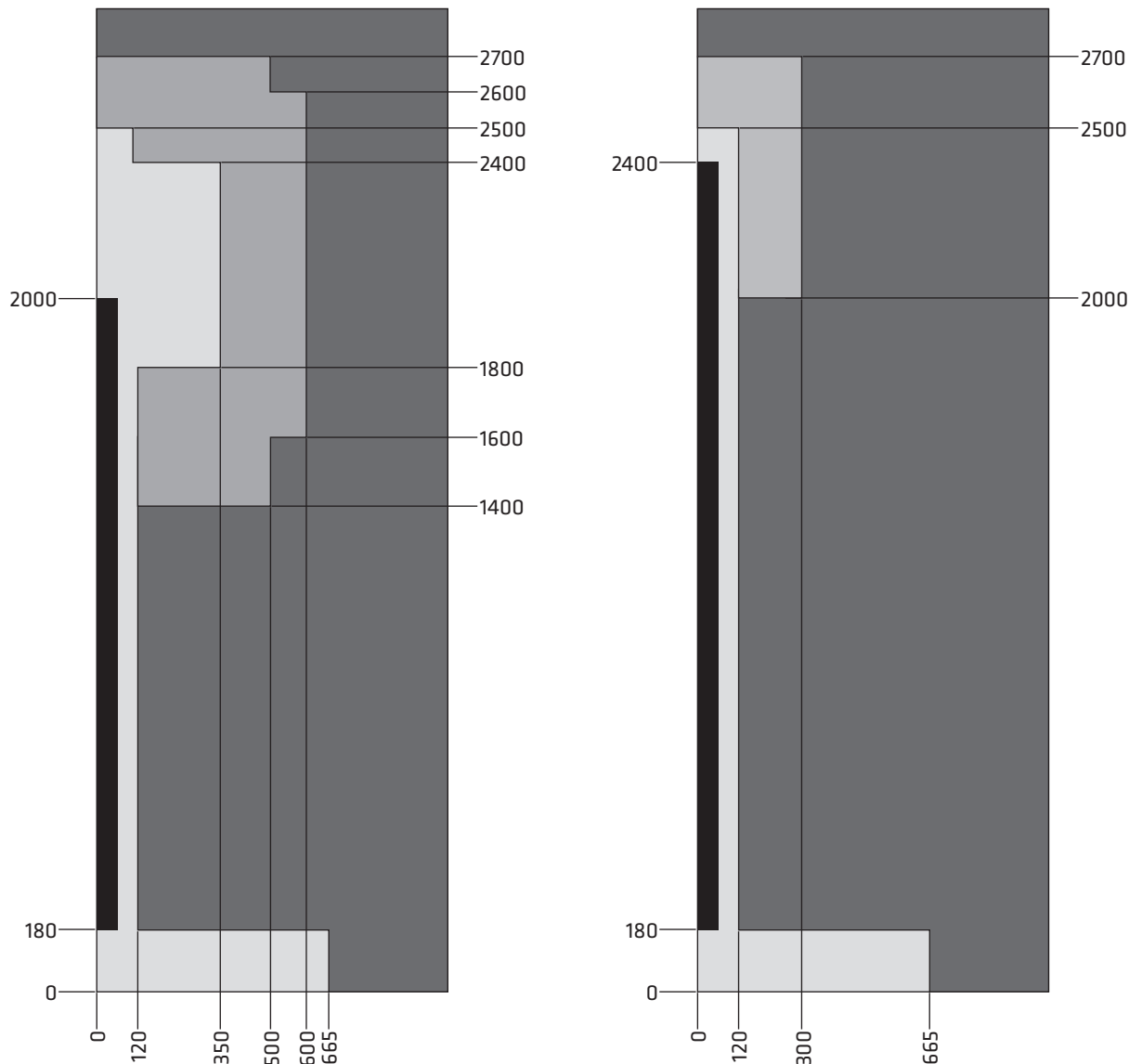

Low risk

High risk

Please note: In the event of a risk posed by slips or misuse, the use of safety distances to prevent hazardous zones being reached by lower limbs in accordance with DIN EN ISO 13857, Annex B may not be suitable. If this is the case, then the safety distances must be defined by the plant manufacturer in accordance with the risk assessment.



Safety distances only apply with the use of ECONFENCE® mesh elements with a mesh size of 19|190 mm. Information on dimensions and weight specifications of the system components can be found in Section 1. Technical data, page 4. The system is only intended to be used on the following surface (see page 10). Only the fastening elements provided are to be used. When installing the electrical equipment (such as cables, switches, control cabinet etc.) for the protective fencing system, the requirements of DIN EN 60204-1 must be observed.

Should you have any further questions, please contact our Customer Service team on +49 (0) 5223 791995-0

5.1. Essential tools

Product



Tools

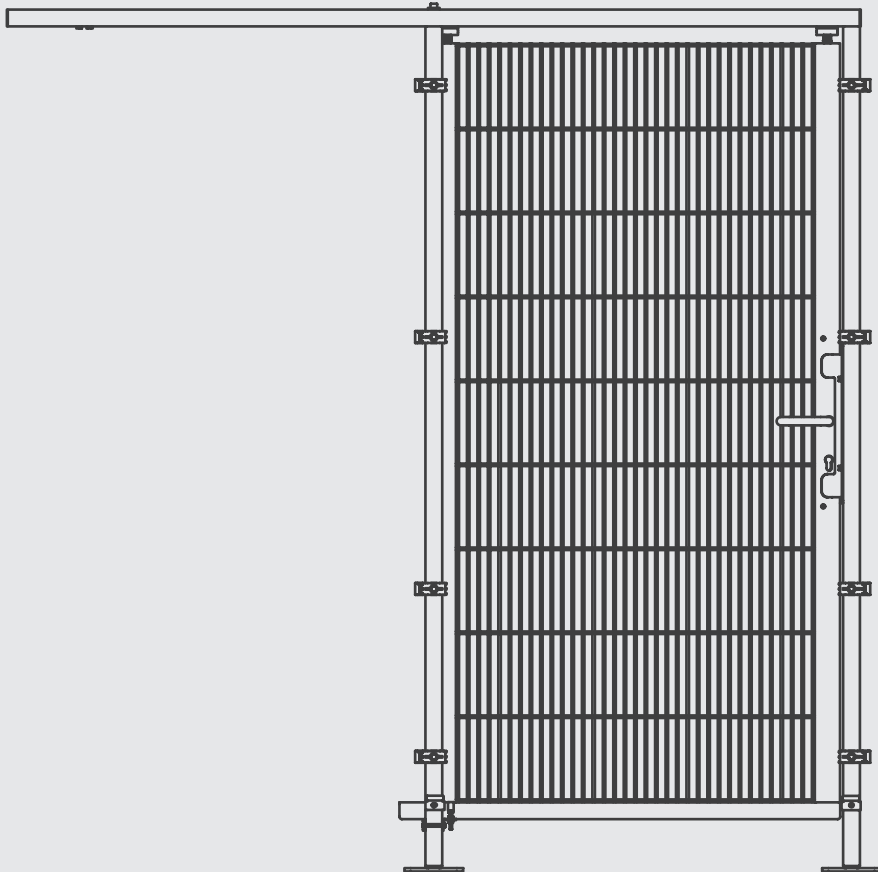

Drill with
10 mm concrete drill bit
Hammer
13 mm and 17 mm socket wrenches
6 mm Allen key

1-leaf sliding door, variant BT01, installation (page 10-13)

5.2. Fastening to the substrate

Substrate material: Concrete (uncracked) C20/25 to C50/60



See page 9

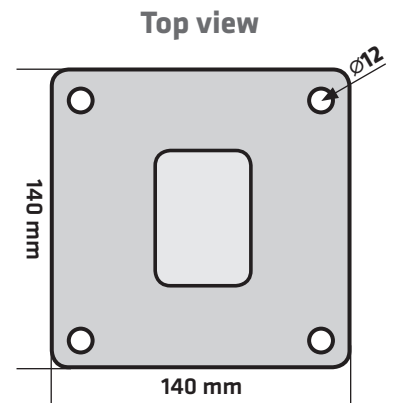
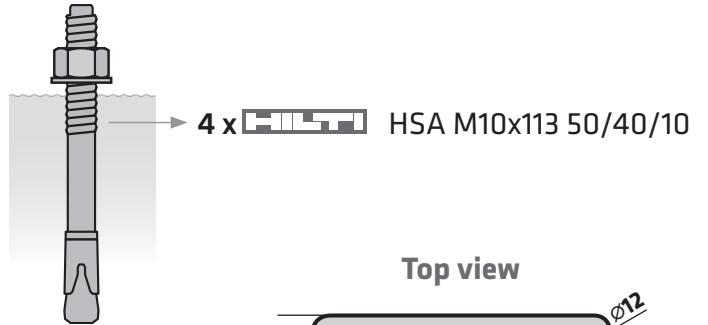
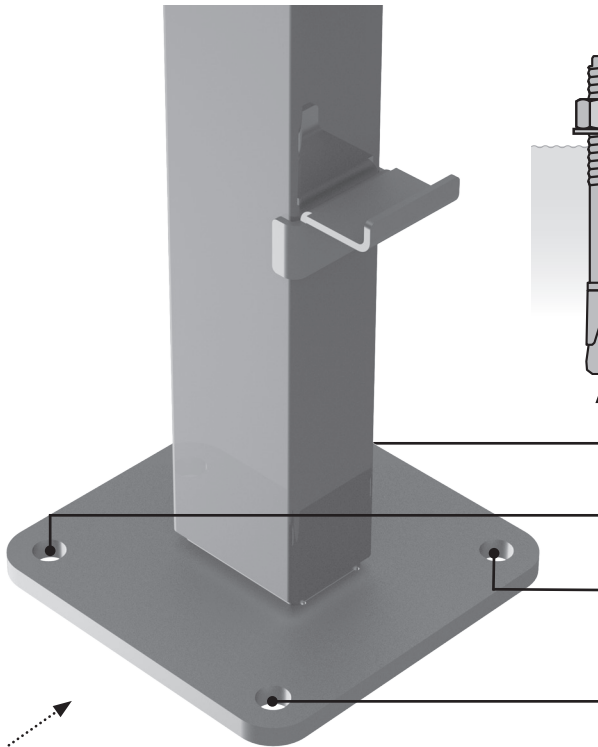
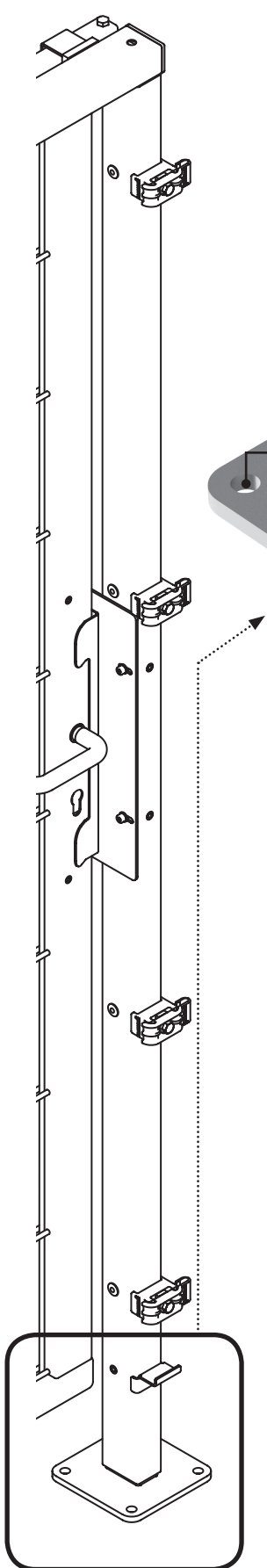

Technical data:

Dowel size	M10
Dowel length	113 mm
Approvals	ETA-11/0374
Substrate material	Concrete (uncracked) C20/25 - C50/60
Environmental factors	Indoors, dry
Edge clearance	50 mm
Operating principle	Torque-controlled expansion anchor
Standard embedment depth	50 mm
Nominal drill diameter	10 mm
Drill hole depth	80 mm
Required tightening torque	25 Nm

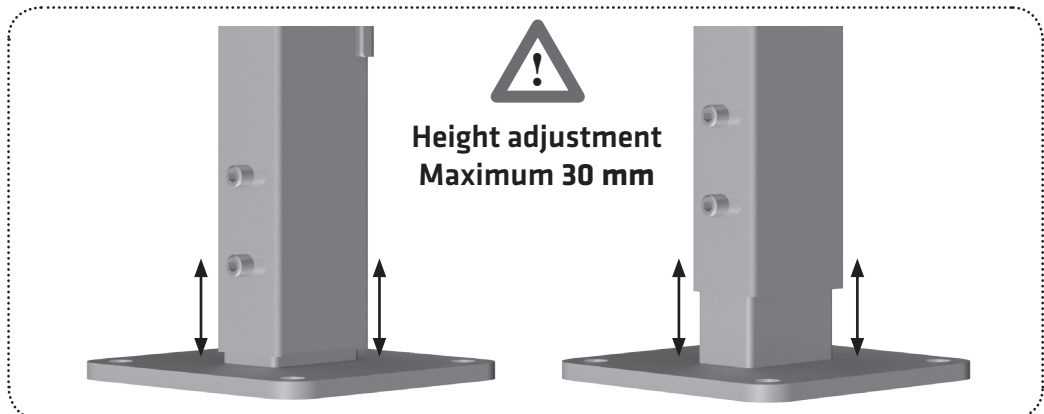

5.3. Interface for fixing locking devices

1-leaf sliding door, variant BT01, as a movable guard in connection with an on-site locking device



For the locking device (safety switch) to be fixed in place, threaded rivets can be set on the door leaf and post in the upper area of the inner side of the door (see illustration below, area marked grey).

 Should you have any further questions, please contact us on +49 (0) 5223 791995-0.

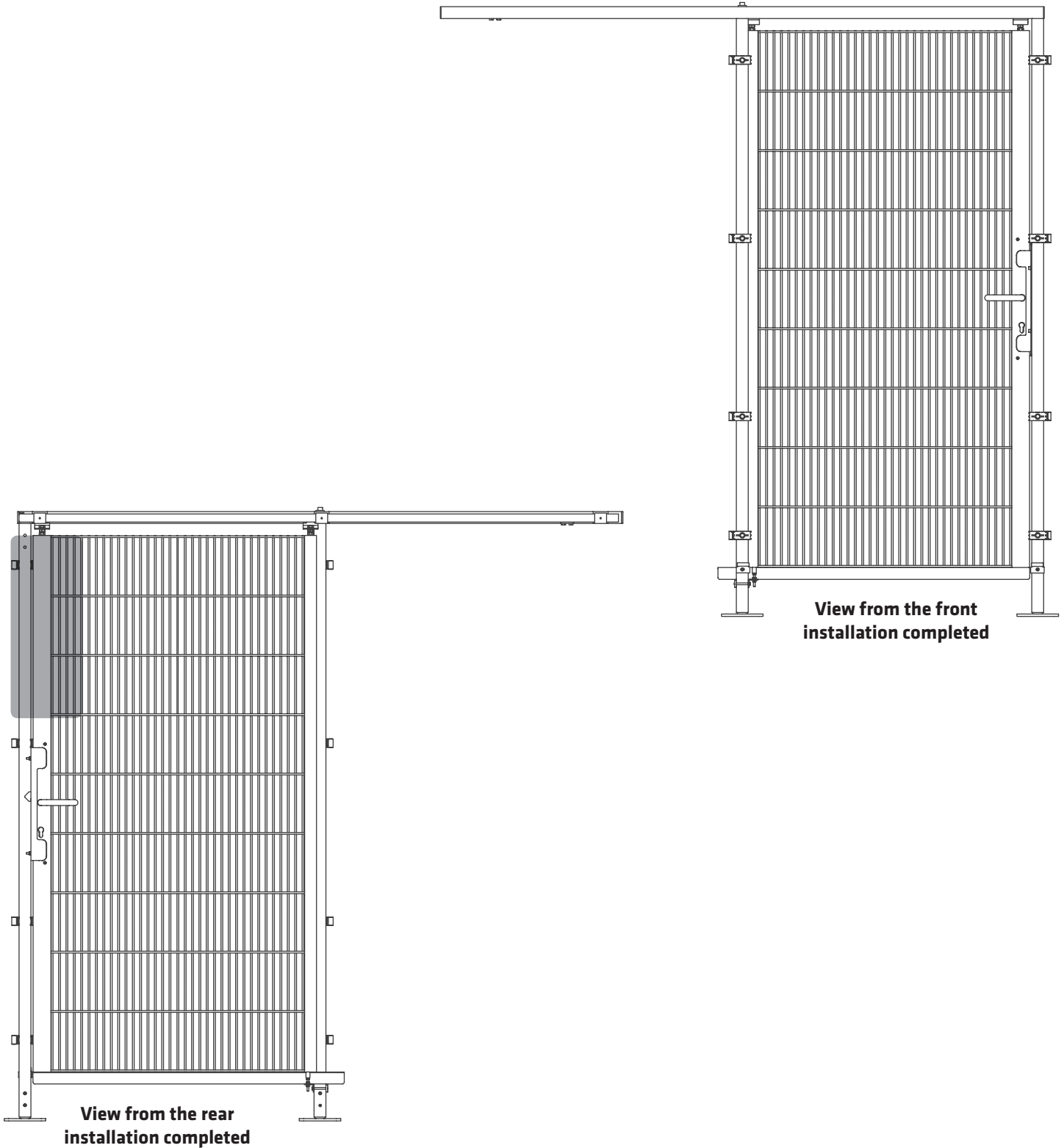



5.4. Installation on the protective mesh

Installation version DIN LEFT

 2053 / 2453 mm

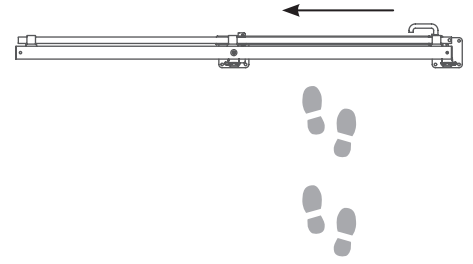
 See page 10



**With mesh assembly
 always make sure that the correct number of vertical mesh
 rods are in the clamping element**
 (see Fig. 1 und 2)

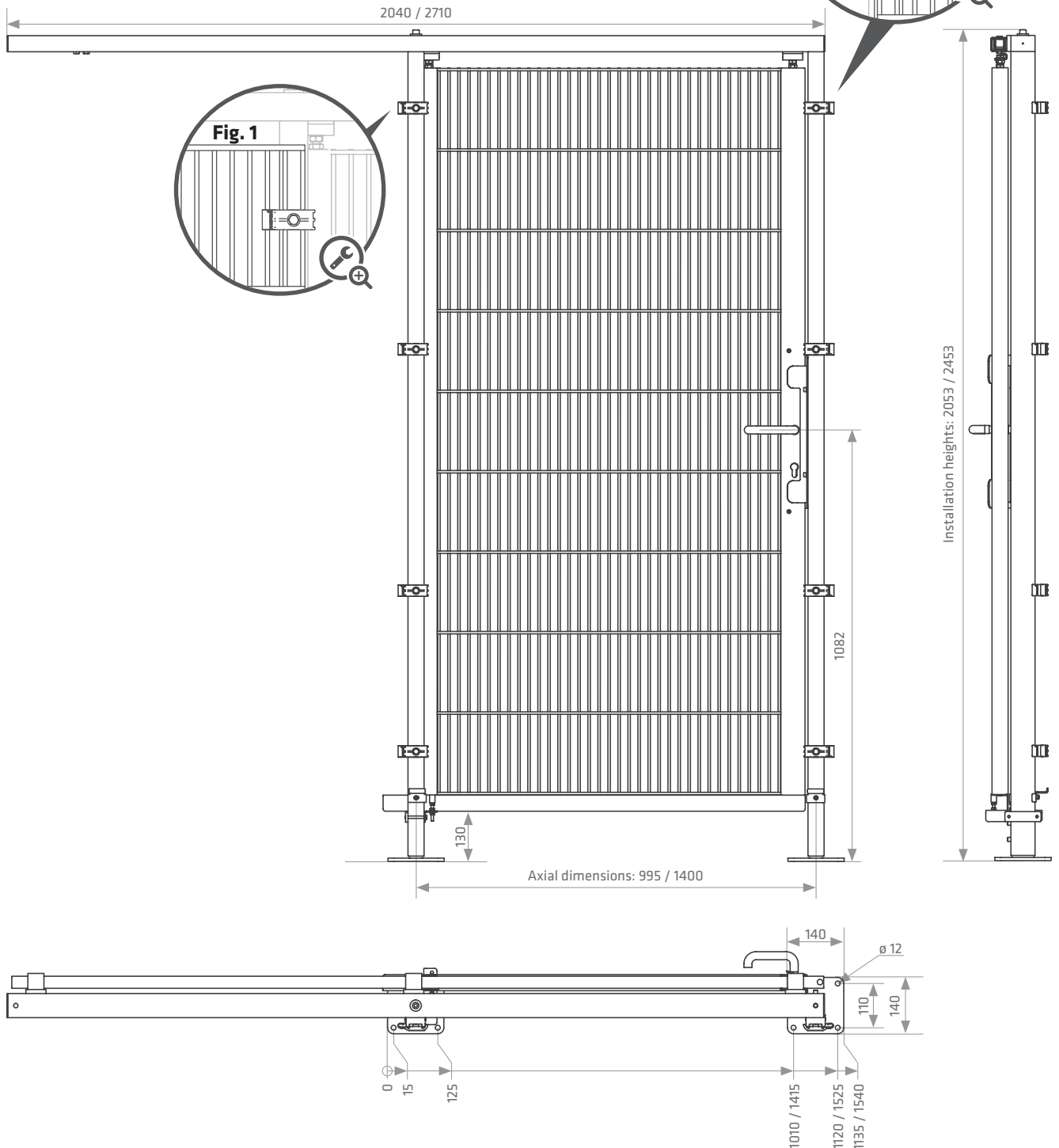
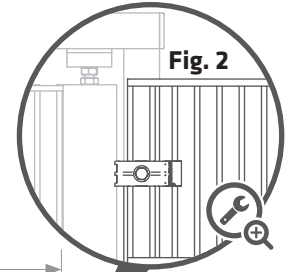

5.4. Installation on the protective mesh

Installation version DIN RIGHT

 2053 / 2453 mm

 See page 10

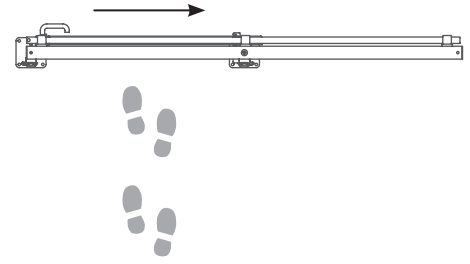

**With mesh assembly
always make sure that the correct number of vertical mesh
rods are in the clamping element
(see Fig. 1 und 2)**

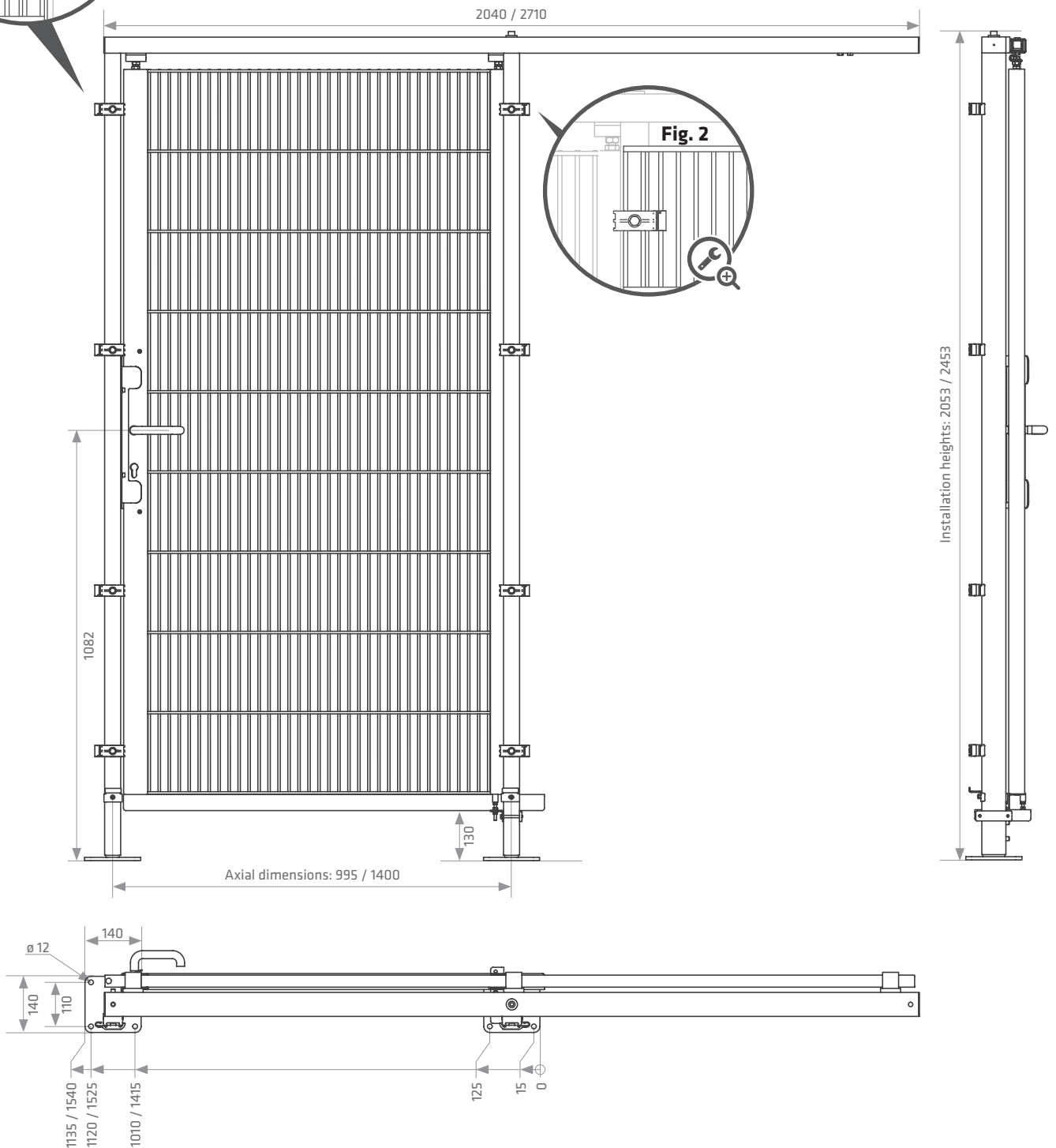
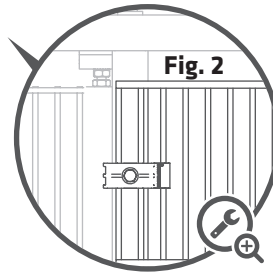
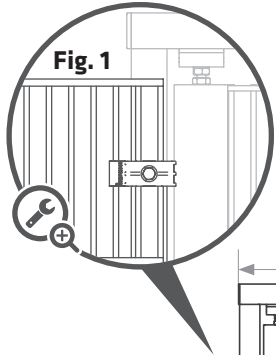

6. Maintenance

The ECONFENCE® protective fencing system is essentially maintenance-free.



Annual checks are to be carried out by specialist personnel to ensure its protective function remains intact. Missing and/or damaged parts must be completed or replaced immediately, taking health and safety at work into account. Only original spare parts may be used.

7. Disassembly and disposal

At least two people are required for disassembly work and these must be specialist personnel.



The machine / system must be switched off before disassembly and secured against unauthorised restarting by means of a lockout/tagout lock. The key must always be carried on your person.

Any electrical equipment attached to the protective fencing system must be disconnected or else made safe.

The system must be disposed of in line with local regulations.

8. Spare parts and accessories

Order no.	Designation	Fig.
ZB20097	Post cap with collar, black plastic, for a post profile measuring 60x40mm	1
ZB31001	Clamping element, black plastic, clamping range 6 mm, with pre-assembled steel screw M8x40 mm	2
ZB21014	Mesh support, row post (rivet version), black plastic, for a post profile measuring 60x40 mm	3
ZB21010	Mesh support, corner post (rivet version), black plastic, for a post profile measuring 60x40mm	4
ZB20024	Aluminium threaded rivet sleeve M8, for drill hole \varnothing 11.1 mm	5
ZB31055	Lower mesh connector for HL/ML row post for post profile 60x40mm, with screw	6
ZB31056	Lower mesh connector for HL/ML corner post, left, for post profile 60x40mm, with screw	7
ZB31057	Lower mesh connector for HL/ML corner post, right, for post profile 60x40mm, with screw	8
ZB31058	Assembly kit mesh fixing (rivet version) for HL/ML row post: 5 x ZB31001, clamping element, black plastic 6 mm, with pre-assembled steel screw 5 x ZB21014, mesh support row post (rivet version), black plastic 5 x ZB20024, aluminium threaded rivet sleeve M8, for drill hole \varnothing 11.1 mm 1 x ZB31055, lower mesh connector for HL/ML row post, with screw	
ZB31059	Assembly kit mesh fixing (rivet version) for HL/M corner or door corner post, left: 5 x ZB31001, clamping element, black plastic 6 mm, with pre-assembled steel screw 5 x ZB21010, mesh support corner post (rivet version), black plastic, 5 x ZB20024, aluminium threaded rivet sleeve M8, for drill hole \varnothing 11.1 mm 1 x ZB31056, lower mesh connector for corner post, left, with screw	
ZB31060	Assembly kit mesh fixing (rivet version) for HL/M corner or door corner post, right: 5 x ZB31001, clamping element, black plastic 6 mm, with pre-assembled steel screw 5 x ZB21010, mesh support corner post (rivet version), black plastic, 5 x ZB20024, aluminium threaded rivet sleeve M8, for drill hole \varnothing 11.1 mm 1 x ZB31057, lower mesh connector for corner post, right, with screw	
S00001	Post insert base for profiles measuring 60x40 mm, 140x140 mm plate, galvanised	9
ZB20025	Hilti stud anchor, galvanised steel, HSA M10x113 50/40/10 for non-cracked concrete	
ZB20027	Hilti capsule adhesive anchor HVU M10x90 with anchor rod HAS M10x90/21 for non-cracked concrete	
ZB20054	Paint spray, RAL 7035 - light grey, 400 ml, gloss	
ZB20055	Paint spray, RAL 1021 - colza yellow, 400 ml, gloss	
ZB20056	Paint spray, RAL 9005 - jet black, 400 ml, gloss	
ZB20057	Paint spray, RAL 9005 - jet black, 400 ml, matt	
ZB40005	Mesh customisations and recesses according to customer layout	

Technical specifications subject to change.

Fig. 1



Fig. 2



Fig. 3

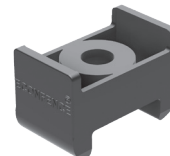

Fig. 4

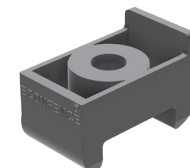

Fig. 5



Fig. 6

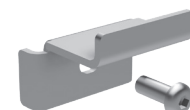

Fig. 7

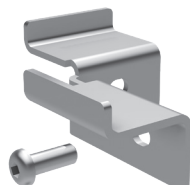

Fig. 8

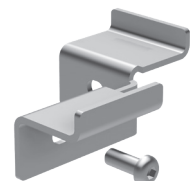
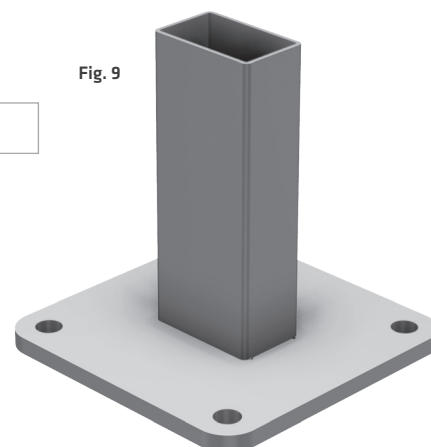

Fig. 9



 Should you have any further questions, please contact us on +49 (0) 5223 791995-0.



...we protect people!

TIEMANN
Schutz-Systeme GmbH
Lübbecker Straße 16
32257 Bünde
Germany
Fon +49 (0)5223 791995-0
Fax +49 (0)5223 791995-90
www.econfence.com
info@econfence.com



BA-100028-2